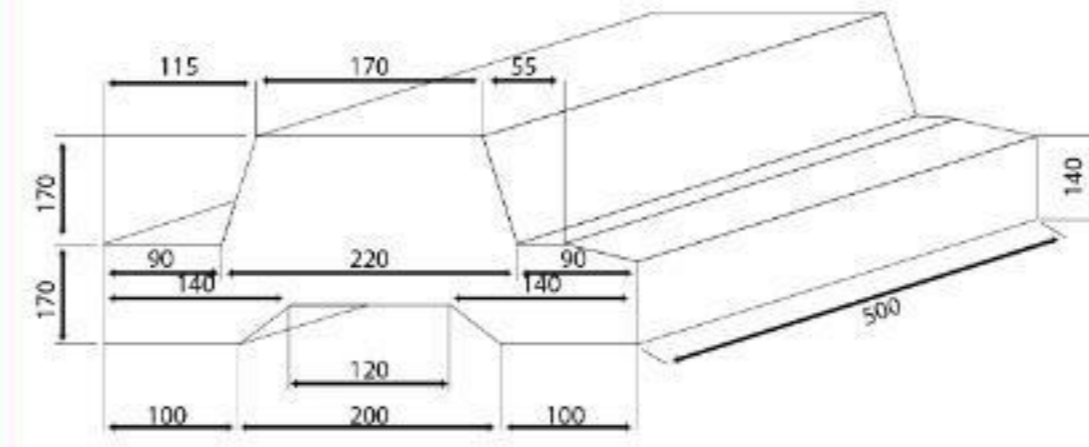
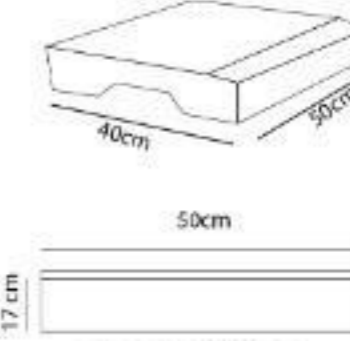
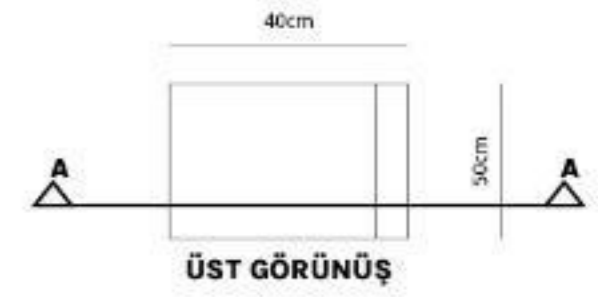
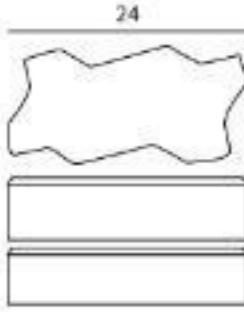

**KİLİT TAŞI**

ölçü-dim.-mm	kg/adet	adet/palet	kg/palet
163x198x60	36	10	1360
163x198x80	36	8	1424
163x198x100	36	9,3	1955

**KABLO KANALLI BORDÜR****PRİZMA TAŞI**

ölçü-dim.-mm	kg/adet	adet/palet	kg/palet
200x100x60	50	11	1496
200x100x30	50	8,8	1538

**KABLO KANALLI SINIR ELEMANLI BORDÜR****ÖN GÖRÜNÜŞ****ÜST GÖRÜNÜŞ****S TAŞI**

ölçü-dim.-mm	adet-pcs/m <sup>2</sup>	m <sup>2</sup> /palet	kg/palet
240x20x60	36	10	1360
240x20x80	36	8	1424

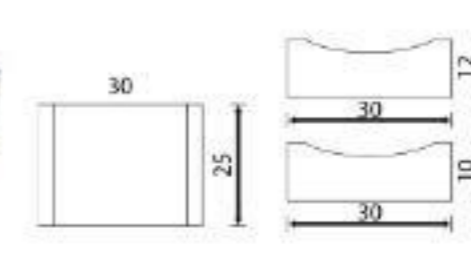
**OLUK**

ölçü-dim.-mm	kg/adet	adet/palet	kg/palet
300x250x100	15,3	81	1240
300x250x120	18,4	81	1490

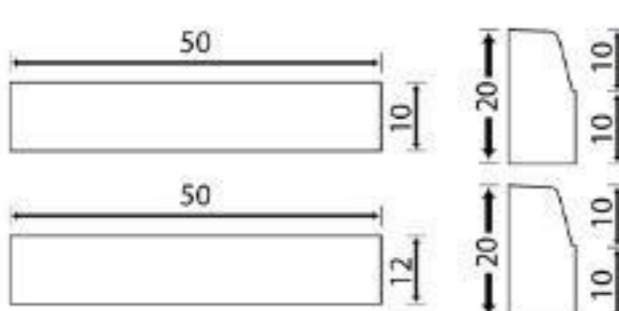
**BAHÇE BORDÜRÜ BELEDİYE BORDÜRÜ**

ölçü-dim.-mm	kg/adet	adet/palet	kg/palet
500x100x200	28,5	54	1539
500x120x200	29,6	54	1600

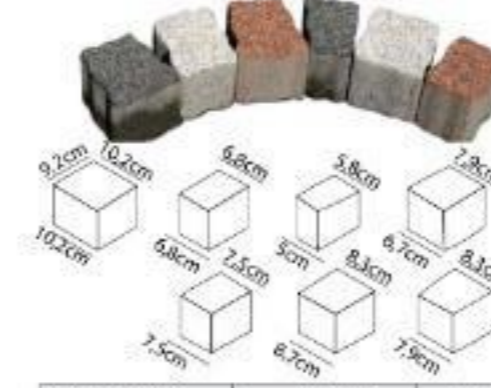
**BEGONİT**

Yükseklik (cm)	M <sup>2</sup> /Adet	Ağırlık
8		180 kg/m <sup>2</sup>

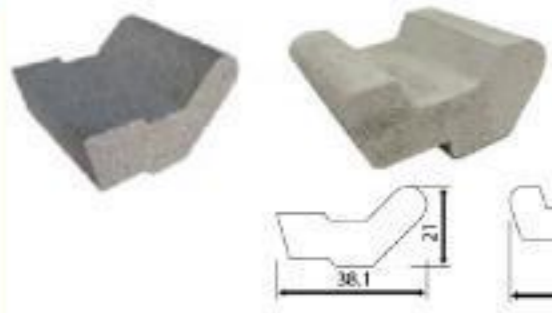
**ŞEV ELEMANI**

ölçü-dim.-mm	kg/adet	adet/palet	kg/palet
381x330x210	33	42	1386
360x300x200	32	42	1344

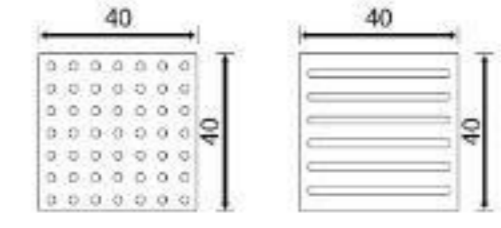
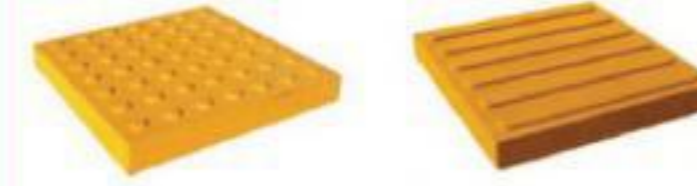
**ENGELLİ TAŞI**

ölçü-dim.-mm	kg/adet	adet/palet	kg/palet
400x400x60	6	7,68	1440
400x400x80	6	7,68	1440

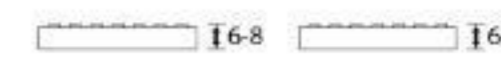



TS 2824 EN 1338 / 29.04.2005  
TS 436 EN 1340 / 29.04.2005  
TS 13686 / 18.02.2016  
TS 13686 / 18.02.2016  
ISO 9001:2015  
ISO 45001:2018  
ISO 14001:2015



Salih Bilinmez Cad. No:185  
Pınarhisar / KIRKLARELİ



S E K  
B E T O N

SEK BETON VE BETON ELEMANLARI  
SAN. TİC. LTD. ŞTİ.